

FACT SHEET

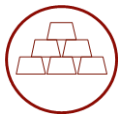

Production
1.4 Moz gold



Mine life of
6 years +



3.3 Moz Resources
1.6 Moz Reserves



Strong community
support and
engagement

Edikan Gold Mine, Ghana, West Africa (“Edikan”)

Highlights:

Perseus Mining is a multi-mine West African gold producer, developer and explorer, with two operating gold mines in Ghana and Côte d’Ivoire, and a third project in development also in Côte d’Ivoire.

The Edikan Gold Mine (EGM) in Ghana was Perseus’ first mine to be developed with commercial production commencing 1 January 2012. Since then EGM has produced over 1.35 million ounces of gold.

EGM comprises a group of large gold deposits located in the Ashanti gold belt 107km south-west by road from Ghana’s second largest city, Kumasi.

The EGM is located on the Ayanfuri and Nanankaw mining leases spanning the border between the Central and Western Provinces of Ghana, covering a total area of approximately 94km².

Perseus owns a 90% interest in Perseus Mining (Ghana) Limited, owner of the EGM, with the remaining 10% owned by the Ghanaian government.

Proved and Probable Ore Reserves total 37.4 million tonnes of ore, grading 1.16 g/t gold containing 1.390 million ounces of gold inclusive of over 2.73 million ounces of Measured and Indicated Resources, as at 30 June 2019.

Perseus implemented an revised Life Of Mine Plan (LOMP) for Edikan from 1 January 2019 which aims to reduce AISC to US\$950/oz by reducing the rate of material movement, reducing mining contractors and staffing and improving operational efficiencies.

LOMP gold production totals 1.08 million ounces over the remaining 6 year mine life, however there is potential to extend the current mine life through exploration and inclusion of the Esuajah South into the LOMP.

FY 2019 PERFORMANCE

- Gold Produced 191,971oz
- Gold Sold 200,933oz
- Milled 6.68 Mt @ 1.09g/t
- All In-Site Costs (AISC) US\$1,049/oz
- Implemented new LOMP 1 Jan 2019 reducing AISC to US\$950/oz for the remaining life of mine
- Asset optimisation and Esuajah South mining studies underway



EDIKAN TIMELINE

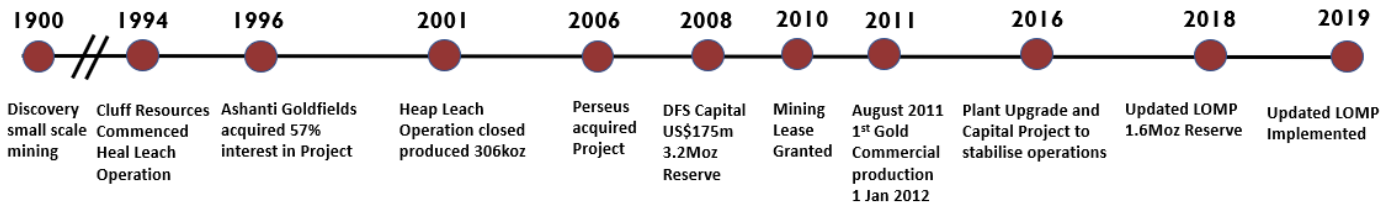

SNAPSHOT

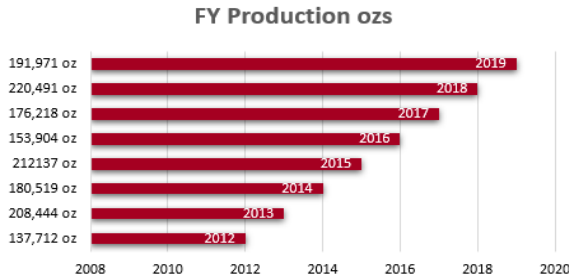

Mineral Resources M&I (June 2019)

Ore Reserves P&P (June 2019)

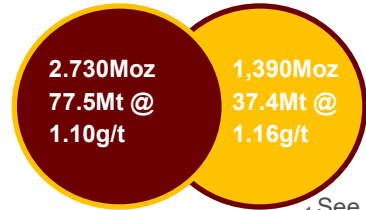

Edikan has produced 1.4Moz of gold since 1st gold production in August 2011.

¹ See our website for further details of Perseus's mineral



OUR VALUES



TEAMWORK

alone we achieve a little, working together we achieve a lot!



INTEGRITY

we act with consistency, honesty and accuracy in everything we do



COMMITMENT

we give our all, every time we do something



ACHIEVEMENT

we do what we say, we deliver on our promises... always



GEOLOGY AND RESOURCES

The area of the EGM is underlain principally by Paleoproterozoic Birimian flysch-type metasediments consisting of dacitic volcanoclastics, greywackes plus argillaceous (phyllitic) sediments, intensely folded, faulted and metamorphosed to upper greenschist facies. Numerous small “Basin-type” or “Cape Coast-type” granite bodies have intruded the sediments along several regional structures.

Gold mineralisation at the EGM occurs principally in the granite bodies, but also in classic “Ashanti-style” sediment hosted shear zones. The granite hosted gold mineralisation is free milling and occurs in two to three generations of abundant, narrow quartz veining associated with up to 3% pyrite, lesser arsenopyrite and traces of sphalerite, chalcopyrite, galena and rutile.

Gold occurs as very fine grains, often along sulphide grain boundaries and in fractures in sulphides, usually at or near vein margins. Coarse visible gold is occasionally observed within the quartz.

Resources as at 30 June 2019 included;

- Measured and Indicated Resources totalled 77.5Mt @ 1.10g/t for 2.73Moz
- Inferred Resources totalled 6.1Mt @ 1.22g/t for 237koz

Edikan is a mature exploration area however activity is ongoing targeting structural, geochemical and granite related targets generated through a conceptual targeting exercise during 2017. Drilling during 2018 on one of these targets identified a previously unknown mineralised granite at Esuajah Gap and drilling is on-going to define Resources and Reserves at Esuajah Gap as well as testing other targets.

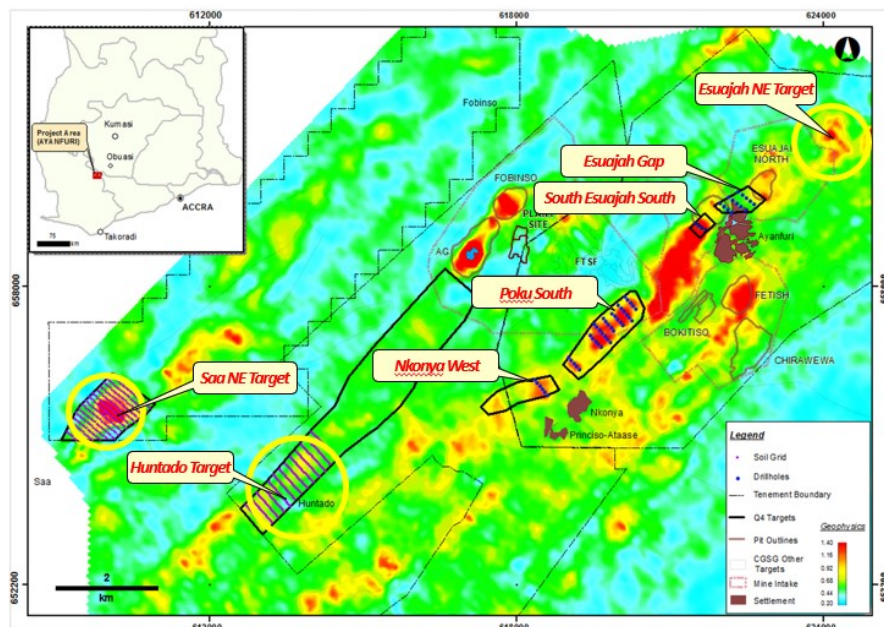

Edikan exploration targets

MINING

An updated LOMP was released in August 2018 and implemented 1 January 2019 the produces 1.08 million ounces over the remaining 6 year mine life at Edikan and an AISC of US\$950/oz.

Ore is sourced from 5 open pits; AF Gap (AFG), Fobinso (FOB), Esuajah North (ESN), Fetish (FET) Bokitsi South (BKS) and historical Heap Leach material.

Average material movements over the remaining LOMP will be 19Mtpa with a strip ratio of 2.9 : 1 and ore processed at an average rate of 6.5Mtpa.

The EGM is a conventional open pit mining operation using a mining contractor to undertake grade control, drill and blast, load and haul and dewatering. The mining contractor is Rocksure International who are a Ghanaian owned mining services business and have been operating at the EGM site since 2016.

RESERVES

Reserves as at 30 June 2019 included;

- Proved and Probable Ore Reserves totalled 37.4Mt @ 1.16g/t for 1.39Moz

Potential open pit and or underground mining at Esujah South (ESS) not currently included in the current LOMP, however approvals to reduce the mandatory blast radius and limit village re-location underway to include at least a portion of the ESS Reserve into the mine plan.

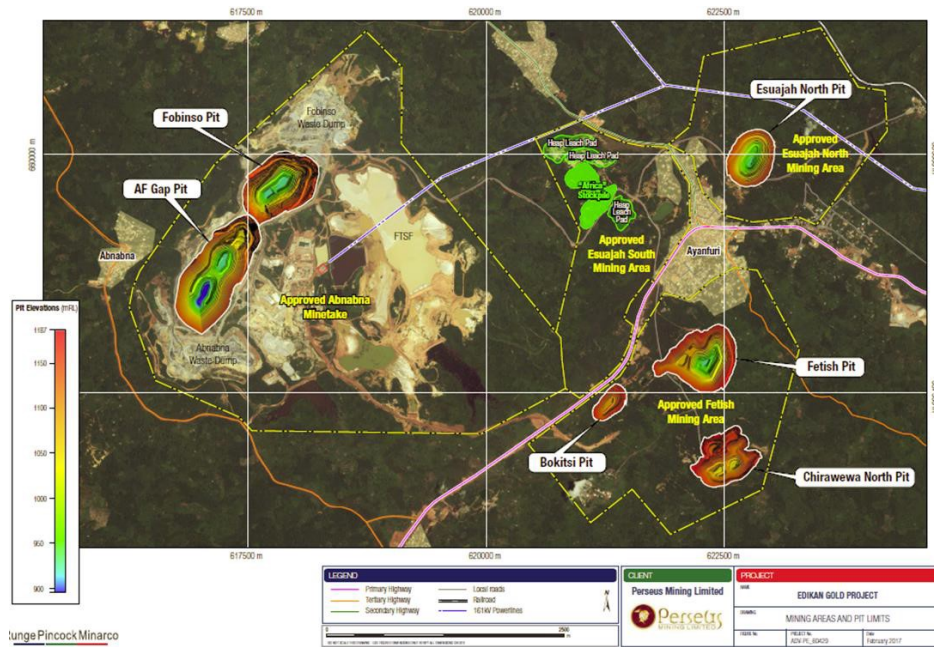

Edikan mining area and site map



PROCESSING

The processing facility at EGM was constructed by MDM and Perseus with first gold poured in August 2011.

The circuit consists of single stage crushing, SAG milling to P_{80} 212 μ m, gravity, sulphide flotation, sulphide regrind to P_{80} 45 μ m and CIL recovery. The plant processed between 6.5 and 7.0 Mtpa depending on the ore hardness.

As at 31 December 2018 1.4 million ounces of gold have been produced at Edikan.

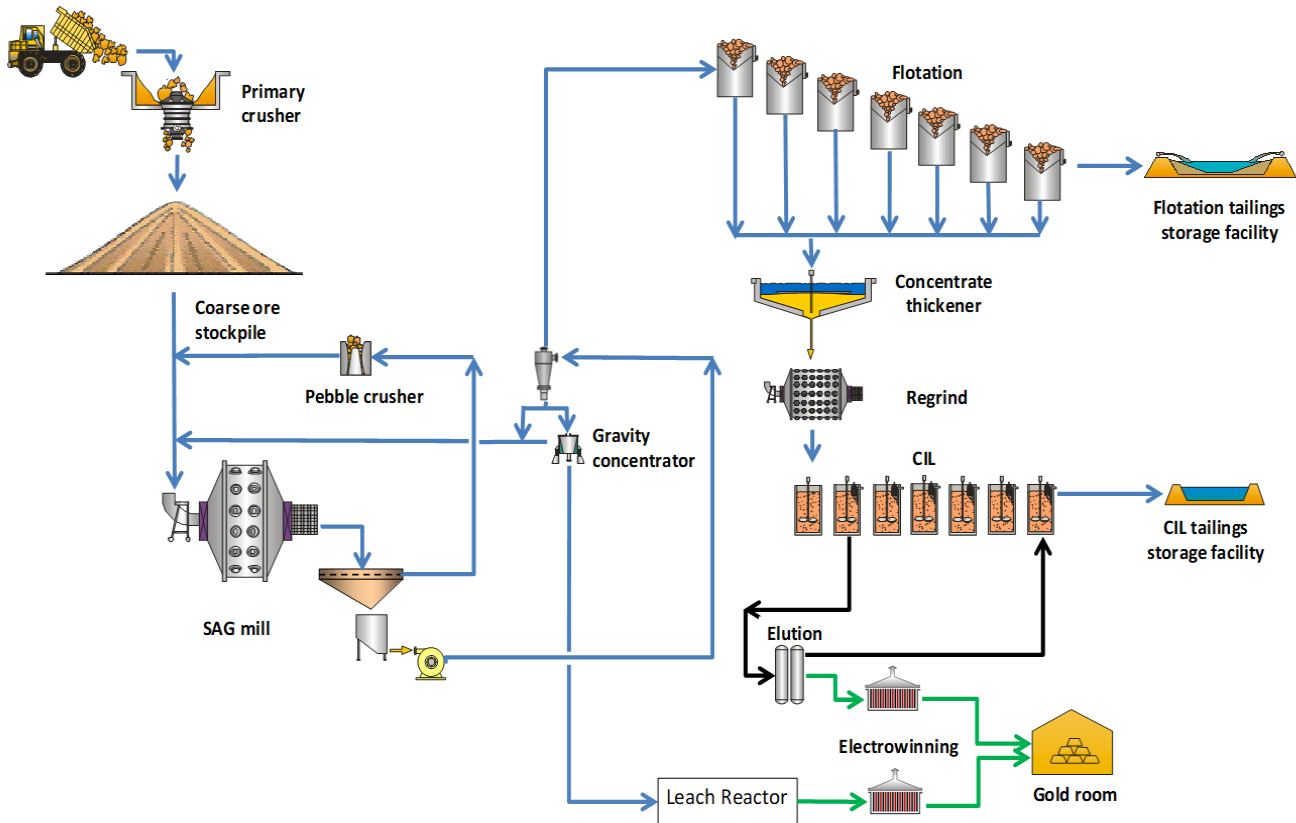

Process Flowsheet

GENERAL

Infrastructure:

- Connection to grid power plus site diesel power generating capacity of 14MW, sufficient to maintain operations
- Water sourced from site capture and storage

Mine workforce:

- Total workforce of 2,771 people including contractors
- 429 direct Perseus employees including 6 expatriates
- 94% of the senior employees are Ghanaian
- 41% from local communities
- 5.7% female employment
- Ghana Mine Workers Union represent operational and senior staff
- Continuous training undertaken to develop workforce and improve skill base



Health & Safety:

- As at 31 December 2018 the 12 month rolling average Lost Time Injury Frequency Rate was 0.71.

COMMUNITY

Perseus believes that strong local community support and engagement is an eventual part of our business model in West Africa.

5 main affected communities; Ayanfuri, Gyaman, Fobins, Abenabena and Nkonya

Activities established to facilitate community engagement include;

- Edikan Trust Fund established for community initiated projects;
- Regular communication with communities and other stakeholders, both formal and informal;
- Formal consultation groups including Crop Negotiation Committee (CNC), Resettlement Negotiation Committee (RNC) & Community Consultation Committee (CCC); and
- Formal grievance procedure in place.

Perseus has an enviable record in community projects in Ghana including:

- Ayanfuri resettlement — 240 structure and new village built for the community displaced by the Esujah North pit;
- 49 structures being constructed to access to the Esujah South pit;
- Road construction and improvements;
- Water bore drilling and pump installations;
- Alternative livelihood project studies; and
- Extensive local employment and services.



ENVIRONMENT

Perseus Mining regards environmental care as an integral part of its business and is committed to excellence in the management of environmental matters.

We aim to minimise environmental impacts at every stage of work from planning, through to exploration, development, mining, processing and decommissioning.

Perseus, through our personnel, will:

- Maintain a comprehensive environmental management system;
- Undertake consultation to ensure that community interests are considered;
- Comply with applicable laws, regulations and standards;
- Provide safeguards and contingency plans to mitigate potential impacts;
- Monitor all activities and strive to continually improve performance; and
- Promote environmental awareness amongst the workforce to increase understanding of environmental responsibilities.

All employees and contractors are responsible for upholding Perseus' standard of environmental management

